

SOVRAPPOSTI - PARALLELI

OVER AND UNDERS - SIDE BY SIDES

SUPERPOSES - JUXTAPOSES



Manuale di Istruzione
Instruction Manual
Mode d'Emploi



BERETTA

Illustrations on pages 5, 11, 28, 29 and 30

READ THIS MANUAL CAREFULLY BEFORE USING THE FIREARM.

KEEP ALWAYS THIS MANUAL WITH YOUR FIREARM. INCLUDE IT WITH THE GUN WHEN IT CHANGES OWNERSHIP OR WHEN IT IS LOANED OR PRESENTED TO ANOTHER PERSON.

NOTICE: The Manufacturer and/or its Local Official Distributors assume no responsibility for product malfunction or for physical injury or property damage resulting in whole or in part from criminal or negligent use of the product, improper or careless handling, unauthorized modifications, use of defective, improper, hand-loaded, reloaded or remanufactured ammunition, customer abuse or neglect of the product, or other influences beyond manufacturer's direct and immediate control.

WARNING: ALL FIREARMS HAVE LETHAL POTENTIAL. READ THE BASIC SAFETY RULES CAREFULLY AND UNDERSTAND THEM FULLY BEFORE ATTEMPTING TO USE THIS FIREARM.

In addition to the Basic Safety Rules, there are other Safety Rules pertaining to the loading, unloading, disassembly, assembly and use of this firearm, located throughout this manual.

WARNING: READ THE ENTIRE MANUAL CAREFULLY BEFORE USING THIS FIREARM. MAKE SURE THAT ANY PERSON USING OR HAVING ACCESS TO THIS FIREARM READS AND UNDERSTANDS ALL OF THIS MANUAL PRIOR TO USE OR ACCESS.

CONTENTS

	Page
BASIC SAFETY RULES	4
NOMENCLATURE	10
SAFETY	11
ASSEMBLY OPERATIONS	12
AMMUNITION	13
LOADING AND FIRING	14
UNLOADING THE SHOTGUN	15
DECOCKING THE HAMMERS	16
DISASSEMBLY OPERATIONS	17
BERETTA MOBILCHOKE® AND OPTIMA-CHOKE® TUBES	18
ADJUSTMENT OF LENGTH OF PULL AND REPLACEMENT OF TRIGGER	20
INTERCHANGEABLE TRIGGER GROUP (DT10 TRIDENT)	21
REMOVING THE STOCK	22
ADJUSTABLE STOCK WITH MEMORY SYSTEM	23
REPLACEMENT OF FIRING PINS (DT10 TRIDENT)	24
MAINTENANCE	24
WARRANTY AND EXTENSION OF THE WARRANTY REPAIR PERIOD	26

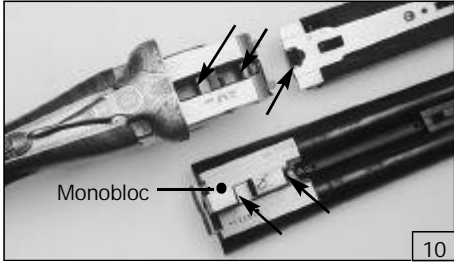
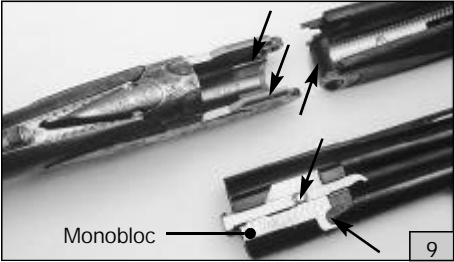

BASIC SAFETY RULES

1. NEVER POINT A FIREARM AT SOMETHING THAT IS NOT SAFE TO SHOOT.

Never let the muzzle of a firearm point at any part of your body or at another person. This is especially important when loading or unloading the firearm. When you are shooting at a target, know what is behind it. Some bullets can travel over a mile. If you miss your target or if the bullet penetrates the target, it is your responsibility to ensure that the shot does not cause unintended injury or damage.



2. ALWAYS TREAT A FIREARM AS IF IT WERE LOADED.

Never assume that a firearm is unloaded. **The only certain way to ensure that a firearm is empty is to open the chamber and visually examine the inside to see if a round is present. Removing the magazine will not guarantee that a pistol is unloaded or cannot fire.** Shotguns and rifles can be checked by cycling or removing all rounds and by then opening the chamber so that a visual inspection of the chamber for any remaining rounds can be made.

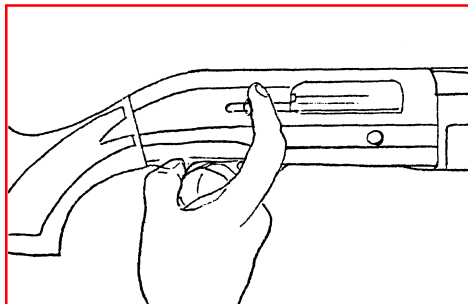
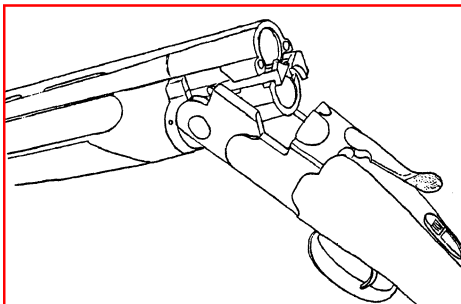
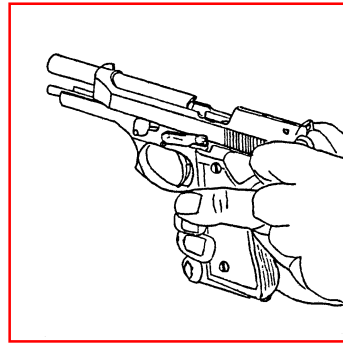

3. STORE YOUR FIREARM SO THAT CHILDREN CANNOT GAIN ACCESS TO IT.

It is your responsibility to insure that children under the age of 18 or other unauthorized persons do not gain access to your firearm. **To reduce the risk of accidents involving children, unload your firearm, lock it and store the ammunition in a separate locked location.** Please note that devices intended to prevent accidents - for example, cable locks, chamber plugs, etc. - may not prevent use or misuse of your firearm by a determined person. Steel gun safes may be more appropriate to reduce the likelihood of intentional misuse of a firearm by an unauthorized child or person.

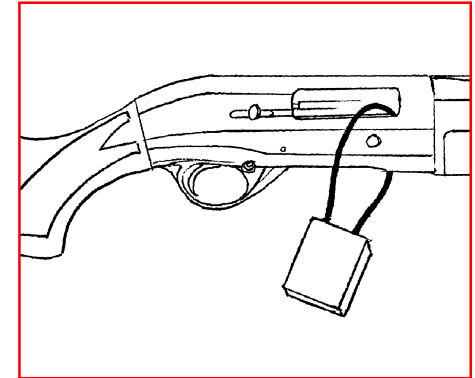
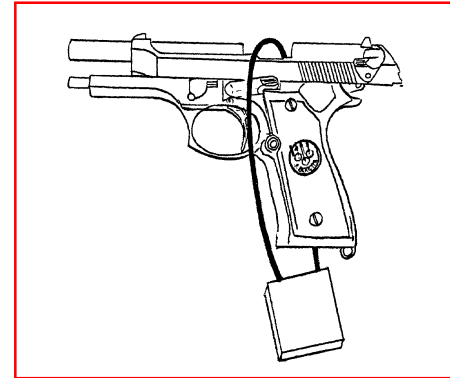

4. NEVER SHOOT AT WATER OR AT A HARD SURFACE.

Shooting at the surface of water or at a rock or other hard surface increases the chance of ricochets or fragmentation of the bullet or shot, which can result in the projectile striking an unintended or peripheral target.

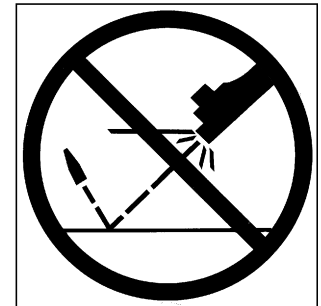

5. KNOW THE SAFETY FEATURES OF THE FIREARM YOU ARE USING, BUT REMEMBER: SAFETY DEVICES ARE NOT A SUBSTITUTE FOR SAFE HANDLING PROCEDURES.

Never rely solely on a safety device to prevent an accident. It is imperative that you know and use the safety features of the particular firearm you are handling, but accidents can best be prevented by following the safe handling procedures described in these safety rules and elsewhere in the product manual. To further familiarize yourself with the proper use of this or other firearms, take a Firearms Safety Course taught by an expert in firearms use and safety procedures.

6. PROPERLY MAINTAIN YOUR FIREARM.

Store and carry your firearm so that dirt or lint does not accumulate in the working parts. Clean and oil your firearm, following the instructions provided in this manual, after each use to prevent corrosion, damage to the barrel or accumulation of impurities which can prevent use of the gun in an emergency. Always check the barrel prior to loading to ensure that it is clean and free from obstructions. **Firing against an obstruction can rupture the barrel and injure yourself or others nearby.**

In case you hear an unusual noise when shooting, stop firing immediately, engage the manual safety and unload the firearm. Make sure the chamber is free from any obstruction or possible bullet blocked inside the barrel due to defective or improper ammunition.



7. USE PROPER AMMUNITION.

Only use factory-loaded, new ammunition manufactured to industry specifications: CIP (Europe and elsewhere), SAAMI (U.S.A.). Be certain that each round you use is in the proper caliber or gauge and type for the particular firearm. The caliber or gauge of the firearm is clearly marked on the barrels of shotguns and on the slide or barrel of pistols. The use of reloaded or remanufactured ammunition can increase the likelihood of excessive cartridge pressures, casehead ruptures or other defects in the ammunition which can cause damage to your firearm and injury to yourself or others nearby.

8. ALWAYS WEAR PROTECTIVE GLASSES AND EARPLUGS WHEN SHOOTING.

The chance that gas, gunpowder or metal fragments will blow back and injure a shooter who is firing a gun is rare, but the injury that can be sustained in such circumstances is severe, including the possible loss of eyesight. A shooter must always wear impact resistant shooting glasses when firing any firearm. Earplugs help reduce the chance of hearing damage from shooting.



9. NEVER CLIMB A TREE, FENCE OR OBSTRUCTION WITH A LOADED FIREARM.

Open and empty the chamber of your firearm before climbing or descending a tree or before climbing a fence or jumping over a ditch or obstruction. Never pull or push a loaded firearm toward yourself or another person.



10. AVOID ALCOHOLIC BEVERAGES OR JUDGMENT OR REFLEX IMPAIRING MEDICATION WHEN SHOOTING.

Do not drink and shoot. If you take medication that can impair motor reactions or judgment, do not handle a firearm while you are under the influence of the medication.



11. NEVER TRANSPORT A LOADED FIREARM.

Unload a firearm before putting it in a vehicle. Hunters and target shooters should load their firearm only at their destination. If you carry a firearm for self-protection, leaving the chamber unloaded can reduce the chance of accidental discharge.



12. LEAD WARNING.

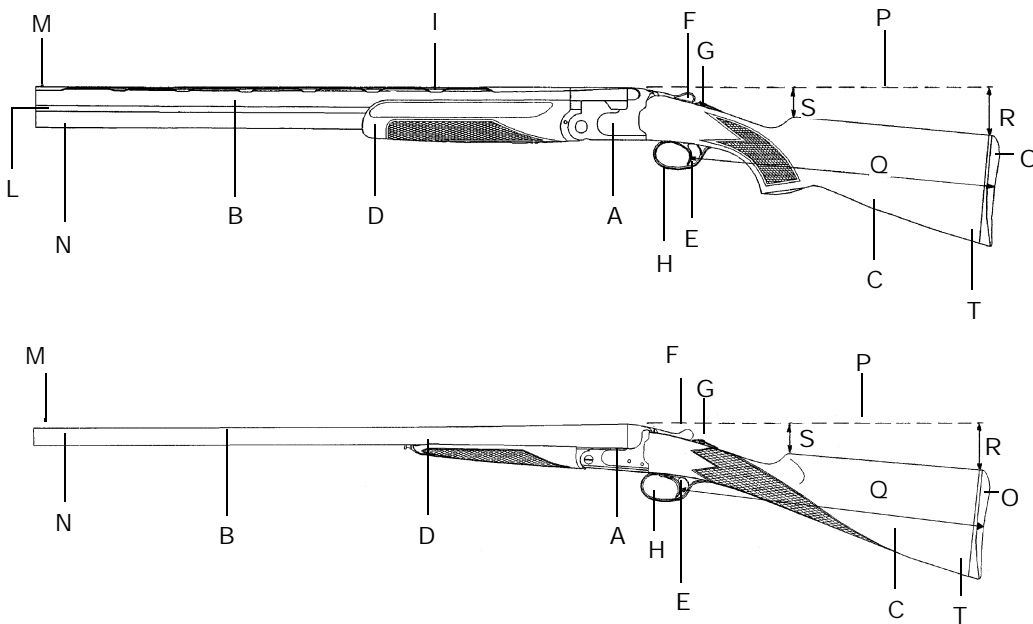

Discharging firearms in poorly ventilated areas, cleaning firearms or handling ammunition may result in exposure to lead and other substances known to cause birth defects, reproductive harm, and other serious physical injury. Have adequate ventilation at all times. Wash hands thoroughly after exposure.

NOMENCLATURE

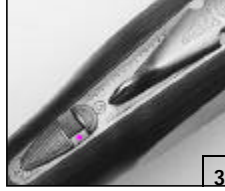
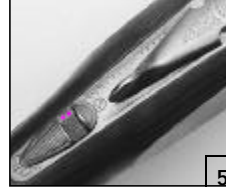

- | | |
|-------------------------------------|-----------------|
| A Action/Receiver | L Side rib |
| B Barrels | M Front sight |
| C Stock | N Muzzle |
| D Fore-end | O Butt plate |
| E Trigger/s | P Line of sight |
| F Top lever | Q Stock length |
| G Safety (with selector on request) | R Drop at heel |
| H Trigger guard | S Drop at comb |
| I Rib | T Toe |

SAFETY

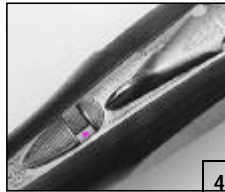
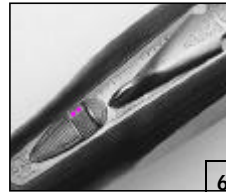
	WITHOUT SELECTOR	WITH SELECTOR on the first barrel	WITH SELECTOR on the second barrel
SAFETY ON			
SAFETY OFF			
		The gun is ready to fire first the cartridge inserted into the bottom barrel (over and unders) or into the right barrel (side-by-sides).	The gun will fire first the cartridge inserted into the upper barrel (over and unders) or into the left barrel (side-by-sides).

WARNING: Do not attempt to make repairs to any firearm without proper knowledge or training. Do not alter parts or use substitute parts not made by Beretta. Any alterations or adjustments that may be necessary to the operating mechanism should be performed by the Manufacturer or by its Local Official Distributor.

NOTICE: The figure numbers noted below refer to the photographs on pages 5, 11, 28, 29, 30.

ASSEMBLY OPERATIONS

WARNING: Beretta assumes no responsibility for any injury or property damage resulting from improper or careless handling, intentional or accidental discharge of the firearm.

The Beretta over-and-under and side-by-side shotguns are shipped partially disassembled (barrel/fore-end and stock/action body). To assemble the shotgun, proceed as follows:

OVER AND UNDER	SIDE-BY-SIDE
Remove the fore-end from the barrels by pulling the fore-end catch lever down. Do not attempt to assemble barrels to receiver with the fore-end attached! Fig. 7	Remove the fore-end from the barrels by pressing the fore-end push button. Do not attempt to assemble barrels to receiver with the fore-end attached! Fig. 8
Wipe excess rust preventative oil from the Monobloc and from the inside surfaces of the receiver (Fig. 9). Swab the bores with a clean cotton patch held on a cleaning rod to remove excess oil. CAUTION: The hinge pin area is a very important mating surface. The receiver and fore-end iron are subject to very high loads: improper lubrication of these components can cause seizing of parts or malfunctioning of the shotgun. (The areas to lubricate are indicated by the arrows on Fig. 9). Before using this shotgun, make sure that lubricant is present as instructed.	Wipe excess rust preventative oil from the Monobloc and from the inside surfaces of the receiver (Fig. 10). Swab the bores with a clean cotton patch held on a cleaning rod to remove excess oil. CAUTION: The hinge pin area is a very important mating surface. The receiver and fore-end iron are subject to very high loads: improper lubrication of these components can cause seizing of parts or malfunctioning of the shotgun. (The areas to lubricate are indicated by the arrows on Fig. 10). Before using this shotgun, make sure that lubricant is present as instructed.
Open the top lever to the right. When barrels are not assembled to the receiver, the top lever remains locked in the open position (right). Fig. 11 CAUTION: The top lever must be in the open position before the barrel is assembled. Failure to do so will cause damage to the ejectors.	Position the rounded surface of the front lug over the hinge pin in the receiver. Fig. 12 CAUTION: The top lever must be kept in the open position before the barrel is assembled. Failure to do so will cause damage to the ejectors.
Insert the Monobloc inside the action so that the hinge pins of the receiver fit into the corresponding slots in the Monobloc. Be sure the small lugs of the ejectors (see the arrow on fig. 13) engage their corresponding slots in the receiver before closing the gun. Fig. 13	Open the top lever and, keeping it pushed to the right, insert the Monobloc locking lugs into the recesses of the receiver. Fig. 14
Swing the barrels upward smoothly and evenly. When the top lever snaps to its centered position, the barrels are locked into the action. Fig. 15	Swing the barrels upward smoothly and evenly. When the barrels are completely closed, let the top lever return to its centered position to allow the locking latch to engage the Monobloc lugs. Fig. 16
Fit the fore-end to the barrels by placing the fore-end iron (the curved steel component at the rear of the fore-end) over the ends of the ejectors against the action so that the fore-end itself slips into position under the barrels. Fig. 17	Fit the fore-end iron (the curved steel component at the rear of the fore-end) against the cocking lever ends protruding from the receiver so that the fore-end itself slips into position under the barrels. Fig. 18

OVER AND UNDER	SIDE-BY-SIDE
Swing the fore-end upward and press carefully to allow the fore-end latch to catch the barrel hook. The operation is done correctly when the fore-end catch lever fits flush with its seat. Fig. 19	Swing the fore-end upward and press carefully to allow the fore-end latch to catch the barrel hook. The operation is correctly done when the fore-end push button protrudes completely from the bore-end bushing. Fig. 20

AMMUNITION

WARNING: Beretta assumes no responsibility for physical injury or property damage resulting from the use of defective, improper, hand-loaded, reloaded or remanufactured ammunition. Serious damage and injury, and even death, could result from the use of incorrect ammunition, from firing against bore obstructions and from propellant overloads.

Beretta over-and-under and side-by-side shotguns feature 2 3/4" (70 mm) and 3" (76 mm) chambers. Models with 3 1/2" (89 mm) chambers are also available. You will find the markings for the gauge and chamber length for your shotgun on the side of the barrel. Every gun has been tested with special proof test ammunition.

WARNING: Never use cartridges that do not correspond to the markings on the side of the barrel.

WARNING: Use only cartridges with a length equal to or less than the chamber length indicated on the side of the barrel.

WARNING: To avoid use of improper ammunition, check markings on the cartridge box and on the cartridge itself to ensure that the correct gauge and length of shell is used for your firearm.

STEEL SHOT

The use of steel shot cartridges is not recommended in either over and under and side-by-side shotguns with fixed chokes. Beretta "SP" Mobilchoke® and Optima-Choke® tubes are designed for use with factory steel shot cartridges loaded to standard specifications. The best results with Beretta "SP" choke tubes are obtained using open chokes (CL, IC, M). Full choke constriction when utilizing steel shot does not increase pattern density and often times distorts normal pattern density associated with lead.

Fixed Chokes and Beretta's Mobilchoke® and Optima-Choke® Designations				
Standard Markings	American Designation	Rim Notches	Choke Tube Compatibility with Steel Shot	Extra Long Tube (Band Colour)
0 (*)	F (full)	I	SP ⁽¹⁾	White
00 (**)	IM (Improved Modified)	II	SP ⁽¹⁾	Black
000 (***)	M (Modified)	III	SP	Green
0000 (****)	IC (Improved Cylinder)	IIII	SP	Yellow
C0000 (C****)	CL (Cylinder)	IIII	SP	Blue
SK (Skeet Beretta) ⁽²⁾	SK (Skeet)	No Notches	SP	Red

⁽¹⁾ Not recommended. ⁽²⁾ Special Beretta skeet choke with negative value. Mobilchoke® and Optima-Choke® are registered trademarks of Fabbrica d'Armi Pietro Beretta S.p.A.

LOADING AND FIRING

WARNING: Read and familiarize yourself with the loading and unloading procedure for this shotgun by reading this manual prior to using the shotgun. Do not use a loaded firearm until you can perform these procedures correctly. Before loading the gun, make sure that the safety is on. A safety is fully engaged only when it can move no further into the safe position. In that position the marking "S" is fully visible (Fig. 1-3-5). A safety which is not fully engaged will not prevent weapon discharge. Always point the firearm in a safe direction!

WARNING: The shooter and bystanders must always wear eye and hearing protection. Particles of shot, lead, powder, lubricant, etc. may cause injury to persons. Hearing protection reduces the risk of hearing damage caused by exposure to shooting noise.

- With the gun assembled (see "ASSEMBLY OPERATIONS"), rotate the top lever to the right and open the chamber by rotating the barrels downwards.
- Hold the barrels up to the light and look down the barrels to make sure that they are free of any obstructions.
- Insert a cartridge of the proper gauge into the chamber of the barrel you want to use, or into both chambers for two shots.
- Close the gun. Be sure that the top lever has moved fully to its center position. Engage the safety if it is not already engaged.

NOTICE: Some models feature an auto-safety device that automatically engages the safety every time the barrel is completely opened.

NOTICE: If the gun features a **DOUBLE TRIGGER**, the pull on the front trigger allows to fire the cartridge inserted into the first barrel (the lower-one in the over and unders and the right-one in the side-by-sides) and the pull on the rear trigger allows to fire the cartridge inserted into the second barrel (the upper-one in the over and unders and the left-one in the side-by-sides).

If the gun features a **SINGLE TRIGGER**, the pull on the trigger allows the gun to fire first the cartridge inserted into the first barrel and then the cartridge inserted into the second barrel.
 If the gun features a **SINGLE SELECTIVE TRIGGER**, the pull on the trigger allows the gun to fire first the barrel you have selected with the barrel selector:
 † (Selector to the left) = first barrel (**Fig. 4**).
 ‡ (Selector to the right) = second barrel (**Fig. 6**).

WARNING: Always point the firearm in a safe direction. Always keep your fingers away from the trigger and keep it free from any form of contact whenever you do not intend to fire. Never point the firearm at something that is not safe to shoot.

- When you are ready to fire, disengage the safety and pull the trigger. This will fire the barrel you have selected to fire first.

WARNING: If the gun does not fire on a live cartridge when the trigger is pulled, activate the safety, wait one minute, then open the chamber and manually extract the unfired cartridge.

NOTICE: The Manufacturer assumes no responsibility for any injury or property damage resulting from improper or careless handling, intentional or accidental discharge of the firearm.

- Completely release the trigger after the first shot to re-set the gun for the next shot. There is no need to operate the barrel selector (if present) since the gun is automatically ready to fire the second cartridge.
- To fire a second shot from the second barrel, pull the trigger again or pull the second trigger.

UNLOADING THE SHOTGUN

WARNING: Do not rely on ejectors to unload your firearm! The selective ejectors do not eject live ammunition. They eject spent shell casings when the chamber is locked opened, while the unfired cartridge/s will be only pulled up. To unload the gun, manually remove the live cartridge/s and check to ensure that both chambers are unloaded.

NOTICE: If the gun features an ejector/extractor selector, the ejector can be transformed into extractor and vice versa by rotating the selector device. (**Fig. 21**)

CORRECT UNLOADING SEQUENCE (Fig. 22)

- After firing or to otherwise unload the gun, engage the safety, move the top lever to the right, open the chamber by holding the receiver in place and by rotating the barrels downwards.

- ‡ The automatic, selective ejectors will only eject spent shell casings. Unfired cartridges will only be extracted (not ejected). Extract them manually.

WARNING: Always unload your firearm before placing it in a vertical position such as against a wall, fence, tree, etc. The gun may fall from a standing position with sufficient force to be discharged.

DECOCKING THE HAMMERS

Decock the hammers using the procedure described below when the gun is unloaded to allow the springs to remain in an uncompressed state.

CAUTION: It is important not to decock the hammers on an unloaded gun without the use of snapcaps to avoid damage to the firing pins.

Procedure:

- ‡ Open the gun. Unload the gun. (See paragraph "Unloading the shotgun").
- ‡ Insert snapcaps into the chambers. Beretta snapcaps are available in the best gun shops.
- ‡ Pull the trigger to decock the first hammer.
- ‡ Move the selector to the second position. (On some models this is not possible since the selector is blocked by a screw.)

NOTICE: If the gun features a **SINGLE NON-SELECTIVE TRIGGER** or a **SELECTIVE, BLOCKED TRIGGER** (inertia type) it is necessary to sharply tap the butt, with your hand, to be able to decock the second hammer.

- ‡ Pull the trigger to decock the second hammer.

To take out the snapcaps without recocking the hammers:

- ‡ Take off the fore-end before you open the gun.
- ‡ Take out the snapcaps, close the gun and replace the fore-end.

DISASSEMBLY OPERATIONS

WARNING: Always be certain the gun is unloaded before attempting disassembly.

To disassemble Beretta over-and-under and side-by-side shotguns, proceed as follows:

OVER AND UNDER	SIDE-BY-SIDE
Check to ensure the chamber is empty. (See paragraph "Unloading the shotgun").	Check to ensure the chamber is empty. (See paragraph "Unloading the shotgun").
Remove the fore-end from the barrels by pulling the fore-end catch lever down. Fig. 7	Remove the fore-end from the barrels by pressing the fore-end push button. Fig. 8
CAUTION: Do not pull the fore-end too far down before pulling it forward to remove it.	CAUTION: Do not pull the fore-end too far down before pulling it forward to remove it.
Move the top lever to the right (Fig. 11). Fully open the chamber by pivoting the muzzle end of the barrels downward. Lift the barrels out of the receiver. Disengage Monobloc recesses from hinge pins (Fig. 13). The top lever remains open.	Move the top lever to the right and keeping it pushed in this position (Fig. 12), open the chamber by pivoting the muzzle end of the barrels downward and lifting the Monobloc locking lugs out of the action (Fig. 14). Let the top lever return to its centered position.
Replace the fore-end onto the barrels and press it to catch the barrel hook.	Replace the fore-end onto the barrels and press it to catch the barrel hook.
NOTICE: It is advisable to place the top lever in its centered position when the shotgun is being stored or transported in a gun case. Proceed as follows: move the top lever completely to the right and depress the top lever plunger (located on the top left section of the breechface of the receiver). Once the top lever plunger is completely depressed, release the top lever to its centered position. Fig. 23	

CAUTION: No further disassembly of component parts is recommended unless done by a competent gunsmith.

BERETTA MOBILCHOKE® AND OPTIMA-CHOKE® TUBES

Mobilchoke® and Optima-Choke® screw-in choke tubes are made of high-grade steel for corrosion resistance and durability. They are designed to withstand the rigors of non-toxic steel shot. Mobilchoke® tubes are fully interchangeable among all Beretta Over and Under and Side-by-Side Mobilchoke® shotguns, while Optima-Choke® tubes are completely interchangeable among all Beretta Over and Under and Side-by-Side barrels with housing for Optima-Choke®.

Extra long Mobilchoke® and Optima-Choke® tubes are also available and are designed to fit both single-barrel and double-barrel shotguns. The grooved extension on the tube allows for easy removal and replacement by hand. If necessary, you can use also the special extra long tube spanner supplied.

Mobilchoke® and Optima-Choke® are registered trademarks of Fabbrica d'Armi Pietro Beretta S.p.A.

REMOVAL OF CHOKE TUBES

WARNING: Check the firearm is unloaded. If not, unload the firearm by operating as described in the chapter "Unloading the shotgun".

WARNING: Never look into the muzzle or change tubes on a loaded gun, even with safety engaged.

- Either open the action or lift the barrel out of the receiver.
- Unscrew (counterclockwise) the choke tubes with the Beretta spanner supplied (Fig. 24).
- Hand unscrew the external choke tubes (Fig. 25). If necessary, use the Beretta spanner supplied (Fig. 26).
- Remove the choke tubes from the muzzle.

CLEANING OF CHOKE TUBES

WARNING: Check the firearm is unloaded. If not, unload the firearm by operating as described in the chapter "Unloading the shotgun".

WARNING: Never look into the muzzle or change tubes on a loaded gun, even with safety engaged.

Procedure:

- Either open the action or lift the barrel out of the receiver.
- Carefully clean the choke housing. If necessary, use a cotton patch coated with Beretta Gun Oil.
- Check the choke to make sure it is perfectly clean inside and outside.
- Apply a thin coat of Beretta Gun Oil to the threads of the barrels and of the choke tubes.

INSTALLATION OF CHOKE TUBES

WARNING: Check the firearm is unloaded. If not, unload the firearm by operating as described in the chapter "Unloading the shotgun".

WARNING: Never look into the muzzle or change tubes on a loaded gun, even with safety engaged.

Procedure:

- Either open the action or lift the barrel out of the receiver.
- Apply a thin coat of Beretta Gun Oil to the threads of the barrels and of the choke tubes.
- Insert the desired chokes into the choke housings.
- Carefully hand screw the chokes into the barrels clockwise. Using the Beretta spanner tighten the chokes until they are fully bottomed into their recesses in the barrels.

NOTICE: To tighten the external choke tubes, it is sufficient to hand-tighten them until seated firmly.

- Remove the spanner after tightening.

WARNING: Periodically check, with the unloaded and opened chambers, whether the chokes are fully and tightly set into the barrel. If necessary, firmly tighten the chokes, using the Beretta spanner, until they can be tighten no more. This tightening is needed to avoid damage to the barrels and to avoid propelling the chokes out of the muzzle when the gun is fired, which may cause damage to the gun or injury to persons.

WARNING: Choke tubes must be kept correctly tightened in the barrels at all times, even during storage and cleaning. Cleaning barrels with no choke tubes in place can push dirt into the barrel threads, causing improper choke installation, rusting, or barrel obstruction.

WARNING: Never shoot choke barrels without using choke tubes. Shooting without choke tubes is very dangerous as debris could be trapped by the threads and create barrel obstructions. It may also cause erratic shot pattern and can damage the barrel's internal screw thread irreparably. Do not alter or modify existing fixed choke Beretta barrels for the use of interchangeable choke tubes. The resulting wall thickness would be too thin to safely contain the pressure levels generated by shooting.

ADJUSTMENT OF LENGTH OF PULL AND REPLACEMENT OF TRIGGER

S 682 GOLD E

The S 682 Gold E competition shotgun comes with a canted trigger corresponding to the cast-on or cast-off stock, while a wide symmetrical trigger is supplied as an accessory.

WARNING: Make sure that the firearm is unloaded before proceeding with the following operations.

Adjustment:

- Completely unscrew the side trigger screw with the supplied screwdriver and remove the screw. **(Fig. 27)**
- Slide the trigger forwards or backwards to the required position, referring to the marks on the trigger base. Reassemble the screw and tighten it with the supplied screwdriver. **(Fig. 28)**

Replacement:

NOTICE: This operation must be carried out by a competent gunsmith.

- Remove the fore-end/barrel assembly from the stock/receiver assembly.
- Place the top lever in its centered position. **(Fig.23)**
- Disengage the safety.
- Completely unscrew the side trigger screw with the supplied screwdriver and remove the screw. **(Fig. 27)**
- By pushing upward and rotating the rear side of the trigger base, completely slide the trigger forwards and off of the trigger base. **(Fig. 29)**

DT10 TRIDENT

The DT10 TRIDENT competition shotgun comes with a wide symmetrical trigger, while a canted trigger corresponding to the cast-on or cast-off of the stock is supplied as an accessory.

WARNING: Make sure that the firearm is unloaded before proceeding with the following operations.

- Loosen the side trigger screw with the supplied screwdriver till it can move freely.

CAUTION: Do not remove the trigger screw to avoid the loss of the internal ball detent.

- Slide the trigger to the required position, referring to the marks on the trigger base. **(Fig. 30)**

- Completely tighten the screw.
- To remove the trigger, completely slide it forward, (towards the barrels) and off of

INTERCHANGEABLE TRIGGER GROUP (DT10 TRIDENT)

The Beretta DT10 Trident competition shotguns feature a completely interchangeable and quickly removable trigger group.

WARNING: Removal and/or installation of the trigger group should be performed only when the gun is unloaded (empty chambers) and the barrels are opened. Beretta assumes no responsibility for any injury to persons or damage to property caused by an accidental discharge of the firearm, resulting from neglect of the BASIC SAFETY RULES and this WARNING.

REMOVAL

Pointing the gun in a safe direction and keeping your fingers clear of the trigger, rotate the top lever to the right to open the gun and make sure that the chambers are empty. If they are not, extract the cartridges. Close the gun.

- A) Push the safety/selector lever all the way forward, pass the "ready to fire" position. You will expose a white dot at the base of the lever and hear a distinctive "click". **(Fig. 32)**
- B) Rotate the top lever to the right and partially open the barrels.

CAUTION: At this point, the trigger group is not locked in place but retained by a spring plunger and may drop out of the receiver if the gun is struck or if it is dislodged by contact with other objects.

- C) Grab the trigger group by the trigger guard and gently pull it downwards to remove it from the receiver. **(Fig. 33)**

NOTICE: To remove the trigger group it is necessary to pull it lightly. If a light pull does not release the trigger group, close the gun and repeat the operations A) and B).

INSERTION

NOTICE: To facilitate inserting the trigger group, ensure that the hammers are cocked.

If the gun is open and the release of the trigger group was performed according to operations A) and B):

- D) Insert the front tang of the trigger group into its corresponding seat in the receiver. Rotate the trigger group up and into the receiver until it snaps into place. **(Fig. 34)**
- E) Close the barrels to lock the trigger group in place.

CAUTION: Until the barrels are closed, the trigger group is held in place only by a spring plunger. It may drop out of the receiver if the gun is struck or if it is dislodged by contact with other objects.

F) In case the shotgun is closed (without the trigger group inserted) open it slightly by carrying out operations A) and B). Then carry out operations D) and E).

REMOVING THE STOCK

The interchangeable stock of this gun can be easily disassembled without removing the recoil pad, thanks to:

- A stock bolt with hexagonal allen head.
- A guiding nut, buried inside the stock, designed to facilitate the insertion of the Allen key supplied and to produce an easy disjunction of the stock from the receiver.
- A recoil pad with central port to allow the Allen key to pass through.

TO REMOVE THE STOCK:

NOTICE: This operation should be carried out by a competent gunsmith.

- Lightly oil the Allen key and insert it into the stock through the recoil pad port (**Fig. 35 and 36**).
- When the Allen key is inserted into the stock bolt hexagonal head, unscrew it turning the key handle counter clockwise until the stock is completely separated from the receiver.

TO REASSEMBLE THE STOCK PROCEED IN REVERSE ORDER.

ADJUSTABLE STOCK WITH MEMORY SYSTEM

WARNING: Check the firearm is unloaded.

The adjustable stock features a "Memory System" device. It allows to fit the stock by modifying the drop (at comb and at heel) and the cast (right or left). The adjustable stock of your shotgun is factory preset with standard measures of drop and cast.

ADJUSTING THE CAST

- 1 Unscrew, with the supplied wrench, the two side screws of the adjustable comb (**Fig.37**)
- 1 Lift the adjustable comb off of the stock.
- 1 Loosen the locking screws of the adjustment mechanism (**Fig 38**) and move it to the right or to the left, obtaining the required amount of cast.
- 1 Tighten the locking screws of the adjustment mechanism, always using the supplied wrench (**Fig. 39**).
- 1 If you want to "memorize" this position for future adjustments, move the arrows of the two sliders (positioned on the sides of the adjustment mechanism) to correspond with the cast indicator situated at the base of the mechanism itself (**Fig. 39-arrow A**). Two scales, at the base of the adjustment mechanism, will indicate the cast position (**Arrow B**). The sliders and the scales will help you to immediately reset the adjustment mechanism according to the positions previously "memorized".
- 1 Reassemble the adjustable comb on the stock.
- 1 Completely tighten the two side screws of the adjustable comb to lock it in the required position.

CAUTION: Use only the supplied wrench.

ADJUSTING THE DROP

- 1 Unscrew the two side screws of the adjustable comb and loosen (by only half-a-turn of the wrench) the central "memory" screw. (**Fig. 40**)
- 1 Move the front and/or the rear part of the adjustable comb upwards or downwards to obtain the required drop measurement.
- 1 Completely tighten only the two side locking screws of the adjustable comb.
- 1 Once the drop adjustment is correct, tighten the central "memory" screw.

NOTICE: The tightening of the central "memory" screw locks the drop position. When you disassemble the adjustable comb from the stock, (to modify the cast or for cleaning), it is sufficient to unscrew only the two side screws. When you reassemble it, the "memorized" drop will be re-established.

- ▮ Check the adjustment of the cast, by mounting the shotgun.
- ▮ To finely adjust the drop, loosen both the central “memory” screw and the two side screws by half-a-turn. When you move the adjustable comb, it will “click” between positions by small increments.
- ▮ When the correct position is found, tighten the three screws.

CAUTION: Use only the supplied wrench.

CAUTION: Periodically inspect your “Memory System” device. Dirt and dust can interfere with the functioning of the adjustment mechanism. The device is made of a high strength technopolymer, reinforced by carbon fibers, that does not require lubrication. Avoid the use of oils or solvents. Clean the surfaces by simply wiping them down with a clean cloth.

REPLACEMENT OF FIRING PINS (DT10 TRIDENT)

NOTICE: These operations must be carried out by a competent gunsmith.

Lower firing pin.

- ▮ Remove the stock (See paragraph “Removing the Stock”).
- ▮ Remove the pin of the firing pin.
- ▮ Remove the firing pin and its spring. Insert the spring and the new firing pin. Orient them to allow the insertion of the pin.

For the **Upper firing pin** repeat the same operations.

MAINTENANCE

On Beretta shotguns, maintenance has been reduced to a minimum, but that minimum must be performed to ensure safe and reliable functioning and a longer service life for the shotgun.

CAUTION: At the end of a day of shooting, clean and lubricate your shotgun. At the end of the hunting season, or annually, have your gun completely cleaned, including internal mechanisms, by a competent gunsmith. Proper periodic maintenance is important for the reliable functioning of any firearm.

WARNING: Before cleaning, make sure the gun is unloaded. Keep the chamber open.

Procedure:

- ▮ Disassemble the firearm.
- ▮ Clean the bore with care by passing a cleaning rod with a cotton patch coated with Beretta Gun Oil to remove combustion residues. If necessary, use a bronze brush. Also include the chambers in your cleaning operation.
- ▮ Run a clean dry patch through the bore to remove oil residues.
- ▮ Lightly oil the inside of the barrels with a clean cotton patch coated in Beretta Gun Oil.

CAUTION: Do not apply excess oil. Accumulation of oil attracts dirt which can interfere with the functioning and reliability of the gun.

- ▮ With similar procedure, clean the internal face of the action body (especially around the firing pin holes) and lubricate lightly.

CAUTION: Do not pour lubricant into the firing pin holes.

- ▮ Clean and lubricate lightly the mechanism of the fore-end iron and relative hook of the barrels.

CAUTION: The hinge pin area is a very important mating surface. The receiver and fore-end iron are subject to very high loads. Improper lubrication of these components can cause seizing of parts or malfunctioning of the shotgun. (The areas to lubricate are indicated by the arrows on **Fig. 9 and 10**. Before using this shotgun, make sure that lubricant is present as instructed.

- ▮ Clean with care the external surfaces of the gun to remove any trace of dirt, sweat and fingerprints. Apply a thin film of Beretta Gun Oil with a cotton patch.

CAUTION: Do not apply excess oil. Accumulation of oil attracts dirt, which can interfere with the functioning and reliability of the gun.

WARNING: Excess oil and grease obstructing the bore - even partially - is very dangerous when firing and may cause damage to the shotgun and serious injury to the shooter and bystanders. Never spray or apply oil to the shotshells. Use lubricants properly: you are responsible for the proper care and maintenance of your firearm.

WARNING: Store your firearm so that children cannot gain access to it. To reduce the risk of accidents involving children, unload your firearm, lock it and store the ammunition in a separate locked location.

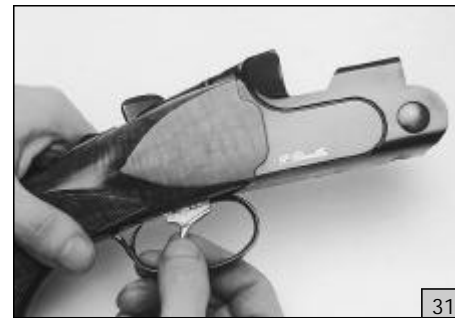
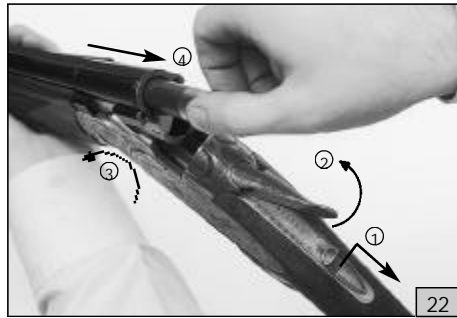
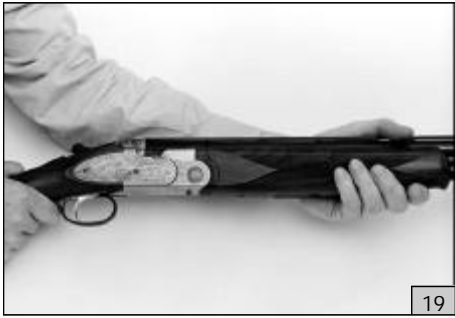

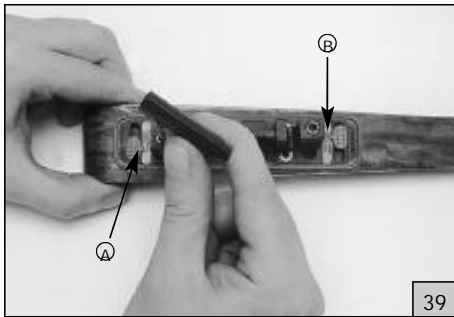
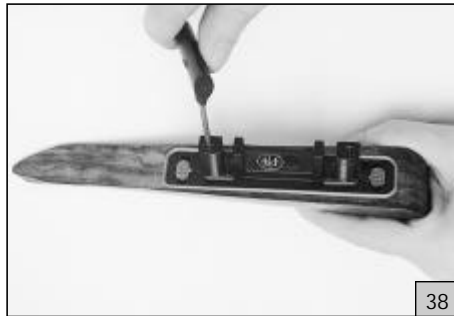

Le illustrazioni e descrizioni di questo opuscolo si intendono fornite a titolo indicativo. La Casa si riserva pertanto il diritto di apportare ai suoi modelli, in qualsiasi momento e senza preavviso, quelle modifiche che ritenesse utili per migliorarli o per qualsiasi esigenza di carattere costruttivo e commerciale.

The illustrations and descriptions given in this brochure are intended as a general guide only, and must not be taken as binding. The Company, therefore, reserves the right to make, at any moment and without notice, any changes it thinks necessary to improve its models or to meet any requirements of manufacturing or commercial nature.

Les illustrations et les descriptions contenues dans ce prospectus ne sont données qu'à titre indicatif. La Maison se réserve le droit de modifier, à tout moment et sans préavis, ses modèles pour les améliorer ou pour n'importe quelle exigence de caractère constructif et commercial.



Fabbrica d'Armi Pietro Beretta S.p.A.
Via Pietro Beretta, 18 - 25063 GARDONE VAL TROMPIA (Brescia) Italia
Tel. (030) 8341.1 - Telex 301523 PB BS I - Telefax (030) 8341.421
Internet: <http://www.beretta.it>